

Why do we need 5-part hematology analyzers?

WBC differential: 3-part

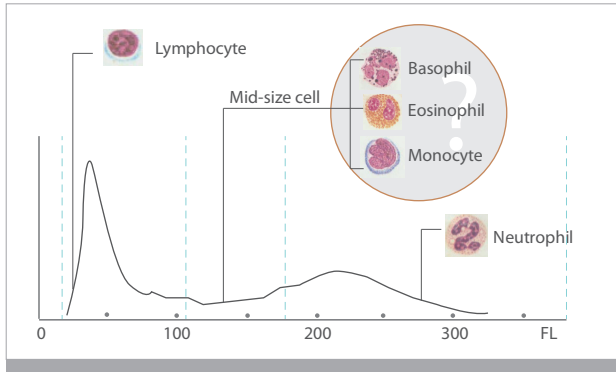

3-part hematology analyzers can not differentiate Basophil, Eosinophil and Monocyte. Additionally, Lymphocyte and Neutrophil results are easily affected by abnormal cells.

Flag information: 3-part

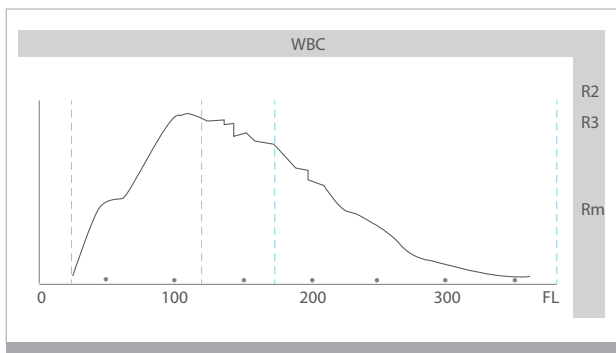

WBC histogram only indicates regional abnormal graph, it can't bring specific flags for different clinical cases.

WBC differential: 5-part

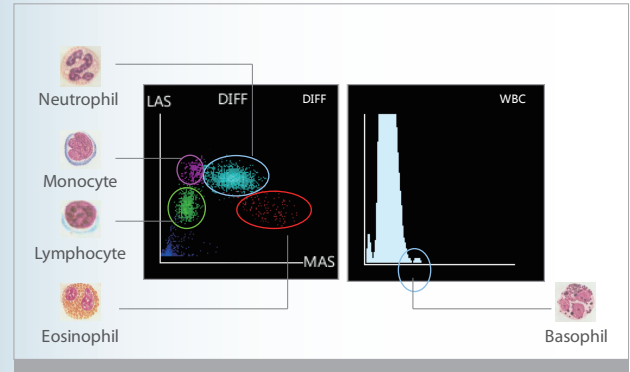

5-part hematology analyzers can provide Lymphocyte, Monocyte, Neutrophil, Eosinophil and Basophil results for every sample. Additionally, the 5-part results are less affected by abnormal cells.

Flag information: 5-part

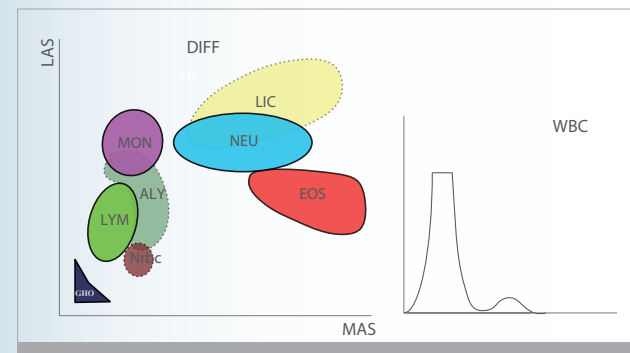

5-part hematology analyzers provide more detailed and specific flag information. Users are able to clearly understand the clinical significance of flags and make a decision.



Dr Marisela Ramos, lab manager

Users are able to access our tailored innovation and intelligent diagnosis support to safeguard their diagnoses decisions with maximum confidence.

She said: "we upgraded to a 5-part hematology analyzer 3 months ago, and it's been working very well. Our lab has lots of abnormal samples, such as Eosinophilia and Monocytosis samples. We could only get the information that the mid-size cells percentage was higher than normal level, but couldn't distinguish which kind of cells increased exactly. Now, the 5-part hematology analyzer provides flags directly, which reduces smears need to be reviewed, and significantly improves our work efficiency."

BC-5150

Auto Hematology Analyzer

Based on Mindray's continuous innovation in hematology field, BC-5150 is especially tailored to assist diagnostic labs who need full CBC + 5-part results, with relatively low daily sample volume, restricted lab space and tight budget.

As the lightest and most compact 5-part hematology analyzer so far from Mindray, BC-5150 is a highly user-friendly and innovative analyzer that offers cost efficient CBC and 5-part white cell differential results. It is targeted to fulfill and exceed the demands of our global customers by providing more accurate, more efficient and more innovative solutions for labs.

WBC 5-part differentiation, 25 reportable parameters and 24 research parameters, 3 histograms and 4 scattergrams

Whole blood mode, Capillary whole blood mode and Prediluted mode

Tri-angle Laser scatter + Chemical dye + Flow cytometry technology

Dedicated optical counting channel for Basophil measurement

Powerful capability of flagging abnormal cells

10.4 inch large TFT touch screen with user-friendly software

Large storage capacity: up to 250,000 samples

Throughput: 60 samples per hour

Sample volume is only 15 μ L which is ideal for pediatrics



Tri-angle laser scatter + focused flow + chemical dye, creating the possibility for a better 5-part WBC differentiation even on samples with high Eosinophil.

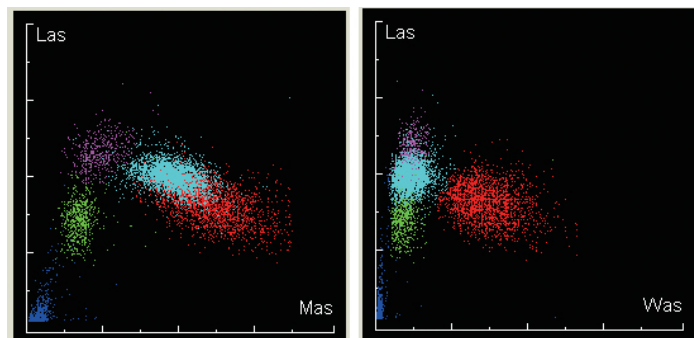
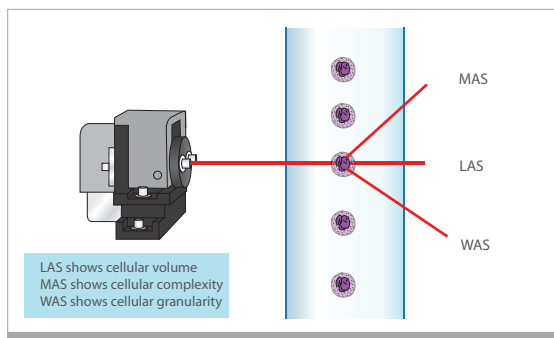

BC-5150, the 5-part hematology analyzer offers a great solution for clinical labs, especially for those who have limited space. Its compact foot-print is a result of innovative technology improvements, including miniaturized semi-conductor laser source, highly integrated electronic boards and optimized liquid handling system.

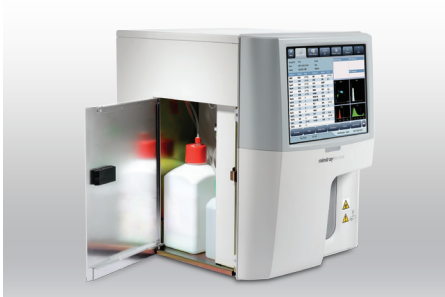

Compact

Two kinds of lyse reagents are located inside of BC-5150, which helps the small labs to save space.



Utility

The 10.4 inch TFT touch screen with a wide viewing angle, brings convenience to clinicians. Users can complete all instrument operations on the screen, practically eliminating the need for an external PC.



BC-5150 inherits its convenient and proven powerful software design from BC-6800 and BC-3600 platforms, the friendly interface is ideal for small sized labs.



Running capillary blood through the sample probe directly is more convenient for the users in children's hospitals, etc. For Prediluted mode, BC-5150 has higher dilution ratio than other 5-part hematology analyzers, thus it brings a better mixing effect.



4 USB ports are located on the instrument's left side. They permit BC-5150 users to transmit data conveniently and connect with printers, keyboard, mouse, barcode scanner, etc.

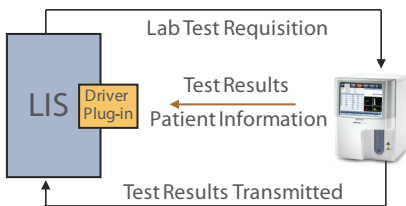

BC-5150 supports bi-directional LIS with test results and patient information. HL7 protocol is supported as well.

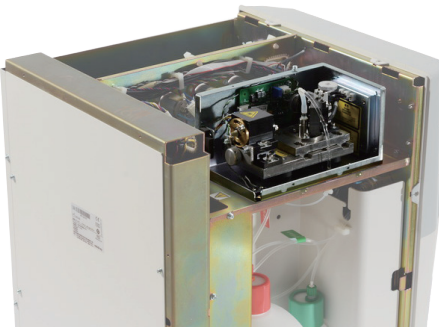

Technology

Compared with traditional helium neon laser or argon laser, semi-conductor laser has smaller size, lower cost and longer life cycle.

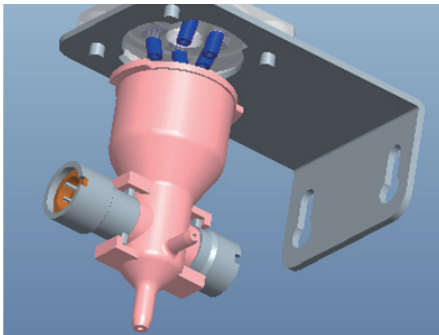

Improved DC impedance technology is used to count and size the RBC and PLT. The smaller counting aperture (50 μm in diameter) provides better performance on samples with low PLT.



Efficient

Only three routine reagents are required. These have 2 years shelf life and also less consumed by BC-5150. Original QC and calibrator are also provided to ensure the hematology analyzer's traceability and testing quality.

Technical Specifications

Principles

Impedance method for RBC and PLT counting
Cyanide free reagent for hemoglobin test
Flow Cytometry (FCM) + Tri-angle laser scatter + Chemical dye method for WBC 5-part differential analysis and WBC counting

Parameters

25 parameters: WBC, Lym%, Mon%, Neu%, Bas%, Eos%, Lym#, Mon#, Neu#, Eos#, Bas#, RBC, HGB, HCT, MCV, MCH, MCHC, RDW-CV, RDW-SD, PLT, MPV, PDW, PCT, P-LCR, P-LCC.
24 research parameters including LIC%, LIC#, ALY%, ALY#, PLT Clump#, PLT Clump%, Lip#, Lip%, NRBC#, NRBC%, Blast#, Blast%, PDW-SD, NLR, PLR, Neu-X, Neu-Y, Neu-Z, Lym-X, Lym-Y, Lym-Z, Mon-X, Mon-Y, Mon-Z
3 histograms for WBC, RBC and PLT
4 scattergrams for WBC differential

Reagent

M-52D Diluent, M-52DIFF Lyse, M-52LH Lyse, Probe Cleanser

Performance

Parameter	Linearity Range	Precision	Carryover
WBC	0-500×10 ⁹ /L	≤2% (4-15×10 ⁹ /L)	≤0.5%
RBC	0-8×10 ¹² /L	≤1.5% (3.5-6.0×10 ¹² /L)	≤0.5%
HGB	0-250g/L	≤1.5% (110-180g/L)	≤0.6%
PLT	0-5000×10 ⁹ /L	≤6.0% (100-149×10 ⁹ /L) ≤4.0% (150-500×10 ⁹ /L)	≤1.0%

Sample Volume

Prediluted mode	20 µL
Whole blood mode	15 µL
Capillary whole blood mode	15 µL

Throughput

60 samples per hour

Display

10.4 inch TFT Touch Screen

Multi-language

Chinese, English, Spanish, Portuguese, Russian, French, Bahasa Indonesia

Data Storage Capacity

Up to 250,000 results including numeric and graphical information

Communication

LAN port supports HL7 protocol

Interface

USB, LAN

Support bi-directional LIS

Printout

External Thermal printer / Laser printer / Inkjet printer, various printout formats and user-defined formats

Operating Environment

Temperature: 10°C~30°C

Humidity: 20%~85%

Air pressure: 70 kPa~106 kPa

Power requirement

100V-240V

50Hz/60Hz

Dimension and Weight

Depth(400 mm) x width(320 mm) x height(410 mm)

Weight :24kg